

LTECH

DMX512 DECODER

LT-932-OLED

32
CHANNEL

OLED display
8 bit / 16 bit
4 kinds of DMX interfaces
Dimming Curve: 0.1-9.9
Short circuit/Over current/Over-heat protection



www.ltech-led.com

Product introduction

1. Designed for Hi-power multiple channels application, 32 channels output, and Max. 3A current per channel, up to 2304W output power.
2. Easy operation with OLED screen and touch buttons.
3. 4 kinds of mode optional: single color, color temperature, RGB and RGBW.
4. Support 4 kinds of DMX ports with signal isolation function: 3-pin XLR, 5-pin XLR, RJ45 and green terminal (with signal amplifier function).
5. With RDM remote management protocol, the operations can be completed via the RDM master console, such as parameters browsing & setting, DMX address setting, equipment recognition, etc.
6. With firmware upgrade function.
7. With short circuit, over current and over-heat protection, as well as warning function when fault.
8. With power-on state management and fast self-testing function.
9. 16bit (65536 levels) / 8bit (256 levels) grey level optional.
10. Optional for standard, linear, LOG or custom 0.1-9.9 dimming curve.

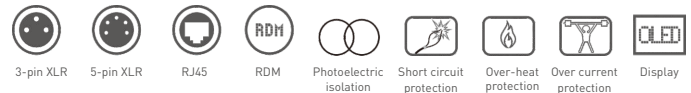
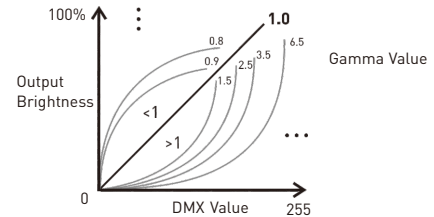

Technical Specs:

Model :	LT-932-OLED
Input Signal :	DMX512/RDM
Input Voltage :	12-24Vdc
Current Load :	3A × 32CH Max 96A
Output Power :	(0-36W...72W) × 32CH Max. 2304W
DMX Interface :	3-pin XLR, 5-pin XLR, RJ45, Green terminal
Control Mode :	Dimming/CT/RGB/RGBW
Dimming Curve :	0.1-9.9
Grey Level :	8bit (256 levels) / 16bit (65536 levels)
Photoelectric Isolation :	Yes
Protection:	Short circuit / Over current / Over-heat
Working Temperature :	-30°C-65°C
Dimensions :	L300×W122×H39mm
Package Size :	L313×W127×H41mm
Weight (G.W.) :	1180g



Product size

Unit: mm

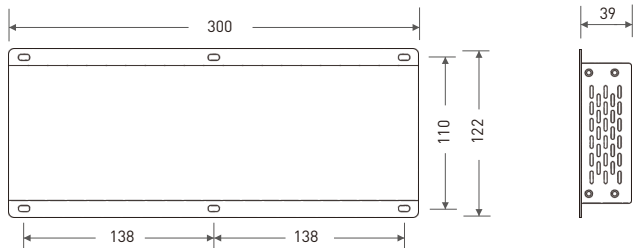

Main Component Description:

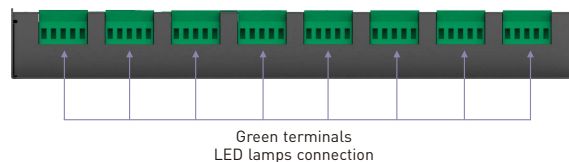
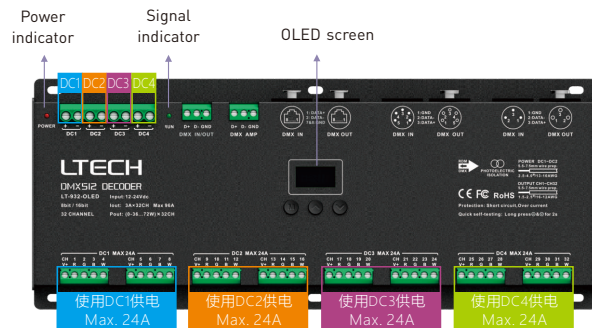

OLED Screen Interface:



Press "M" key, switch entries.
 Long press "M" key, back to main page.
 Press "^" or "v" key, parameter adjustment.
 Exit: back to previous page.

1. DMX address setting

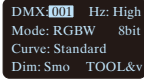

Main page

Press "^" or "v" key to set DMX address.
 Range: 001-512

2. PWM frequency

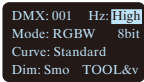

Press "^" or "v" key to choose. **No flicker in video camera.**

Optional :

Std (standard)
 High
 Mid (middle)
 Low

Smooth and exquisite, human eye is comfortable. * It is recommended to use standard.

3. Mode

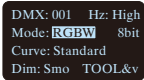

Press "^" or "v" key to choose.

Optional : Dim
 CT
 RGB
 RGBW

4. Grey scale

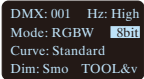

Press "^" or "v" key to choose.

Optional : 8bit
 16bit (choose it if the master controller support this function)

5. Dimming curve

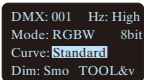

Press "^" or "v" key to choose.

Optional : Standard
 Linear
 LOG
 0.1-9.9
 It is recommended to use standard, 0.1-9.9 is for special requirements.

6. Enhance Dimming

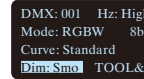

Press "^" or "v" key to choose.

Optional : Std (standard)
 Smo (smooth)

* It is recommended to use standard.

Smo: This option with smooth processing, realize the dimming flicker-free and dynamic effects more downy.

7. Tool

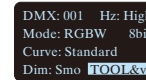

Press "^" or "v" key to enter submenu

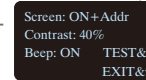

Press "^" or "v" key to enter submenu of test.



Screen: ON+Addr
 Screensaver open and display address if undo for 2 minutes.

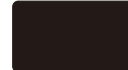

Screen: ON+black
 Screensaver open and black if undo for 2 minutes.

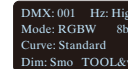

Screen: OFF
 Screensaver not enable.

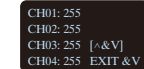

Brightness setting (range: 0-255)
 Press "^" or "v" to next page
 Press "v" to exit

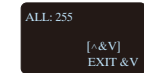

Change all value simultaneously (on the last page)

* Fast self-testing function: press "^" or "v" keys simultaneously for 2-3 seconds under any page, decoder will enter self-testing function.

Wiring diagram

1 Connecting LED lights:

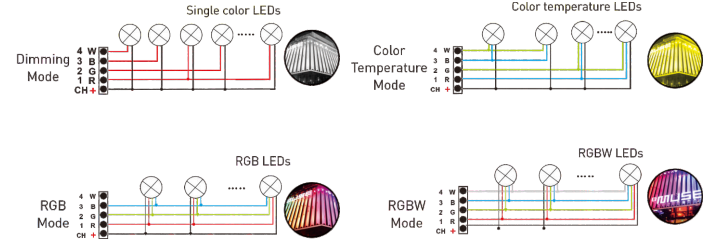
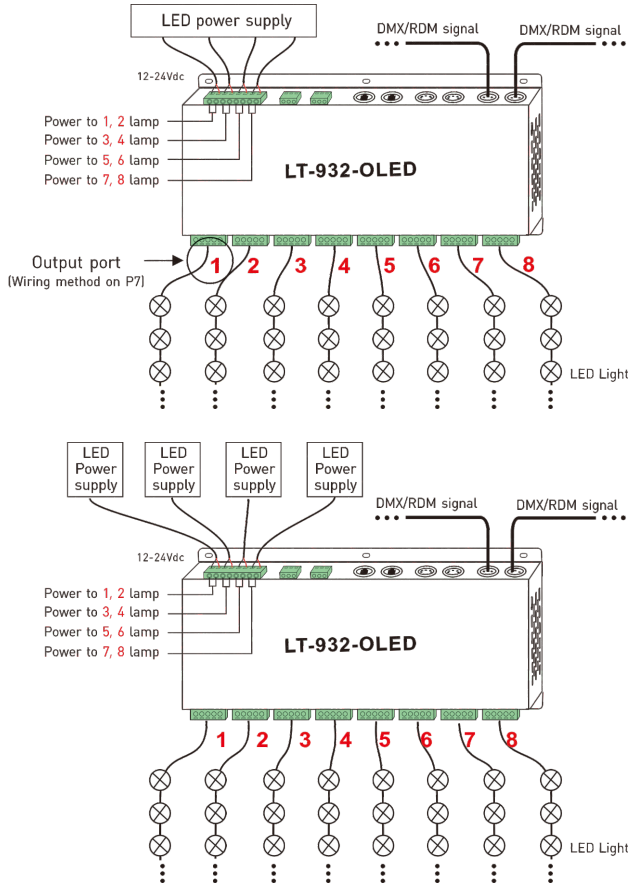

2. DMX console connection:

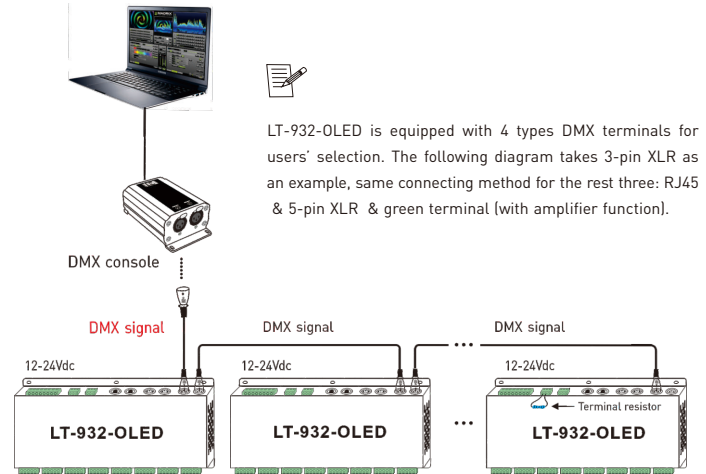

LT-932-OLED is equipped with 4 types DMX terminals for users' selection. The following diagram takes 3-pin XLR as an example, same connecting method for the rest three: RJ45 & 5-pin XLR & green terminal (with amplifier function).

* If the recoil effect occurs because of longer signal line or bad line quality, please try to connect 0.25W 90-120Ω terminal resistor at the end of each line.

3. The connection diagram of 4 kinds of DMX/RDM terminals:

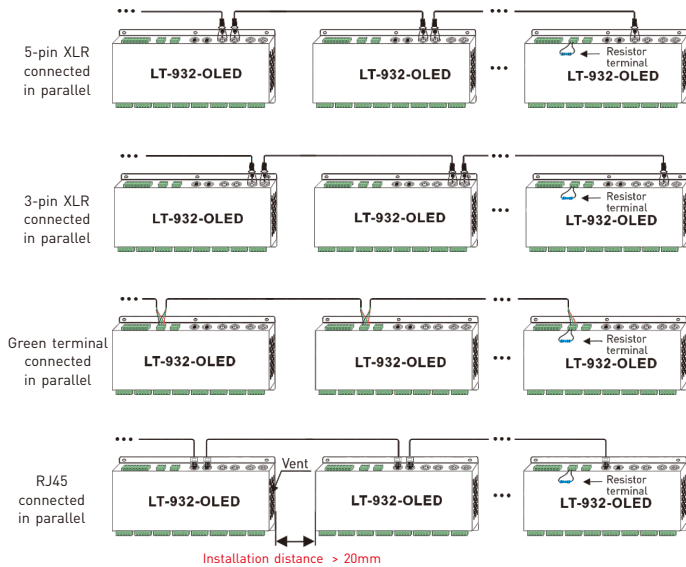

These 4 terminals can be connected in a mixed way.

- * **Installation Attention** : please reserve enough ventilation distance between decoders (>20mm), be sure not to block the vent, or will affect lifetime of decoder for poor heat dissipation.

4. The connection diagram of AMP signal amplifier terminal:

- * Connecting with green terminal or an extra amplifier will be needed when more than 32 decoders are connected or use overlong signal wire(as shown below). Signal amplifier should not be more than 5 times continuously.

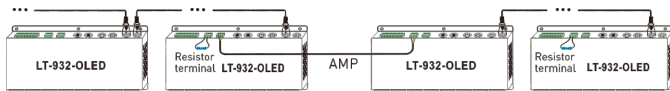

Address setting table

Mode	DIM	CT	RGB	RGBW
Address Quantity	8	16	24	32
Resolution	8bit	8bit	8bit	8bit
1	001	001	001	001
2	001	002	002	002
3	001	001	003	003
4	001	002	003	004
5	002	003	004	005
6	002	004	005	006
7	002	003	006	007
8	002	004	006	008
9	003	005	007	009
10	003	006	008	010
11	003	005	009	011
12	003	006	009	012
13	004	007	010	013
14	004	008	011	014
15	004	007	012	015
16	004	008	012	016
17	005	009	013	017
18	005	010	014	018
19	005	009	015	019
20	005	010	015	020
21	006	011	016	021
22	006	012	017	022
23	006	011	018	023
24	006	012	018	024
25	007	013	019	025
26	007	014	020	026
27	007	013	021	027
28	007	014	021	028
29	008	015	022	029
30	008	016	023	030
31	008	015	024	031
32	008	016	024	032

Channel

Mode	DIM	CT	RGB	RGBW
Address Quantity	16	32	48	64
Resolution	16bit	16bit	16bit	16bit
1	001 002	001 002	001 002	001 002
2	001 003	003 004	003 004	003 004
3	001 002	001 002	005 006	005 006
4	001 002	003 004	005 006	007 008
5	003 004	005 006	007 008	009 010
6	003 004	007 008	009 010	011 012
7	003 004	005 006	011 012	013 014
8	003 004	007 008	011 012	015 016
9	005 006	009 010	013 014	017 018
10	005 006	011 012	015 016	019 020
11	005 006	009 010	017 018	021 022
12	005 006	011 012	017 018	023 024
13	007 008	013 014	019 020	025 026
14	007 008	015 016	022 023	027 028
15	008 008	014 024	024 030	
16	007 008	015 016	023 032	
17	009 010	017 018	025 034	
18	009 010	019 020	027 036	
19	009 010	017 018	029 038	
20	009 010	019 020	030 040	
21	011 012	021 031	041 042	
22	011 012	023 033	043 044	
23	011 012	021 032	045 046	
24	011 012	023 034	047 048	
25	013 014	025 026	038 050	
26	013 014	027 028	039 040	
27	013 014	025 026	041 042	
28	013 014	027 028	041 042	
29	015 016	029 030	043 058	
30	015 016	031 032	045 046	
31	015 016	029 030	047 062	
32	015 016	031 032	047 064	

Channel

Work with RDM editor

LT-932-OLED can work with LTECH RDM editor (Model: WiFi-RDM01) to realize changing the parameters by long-range setting, wiring diagram as below:

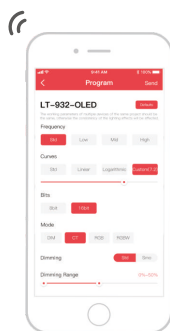
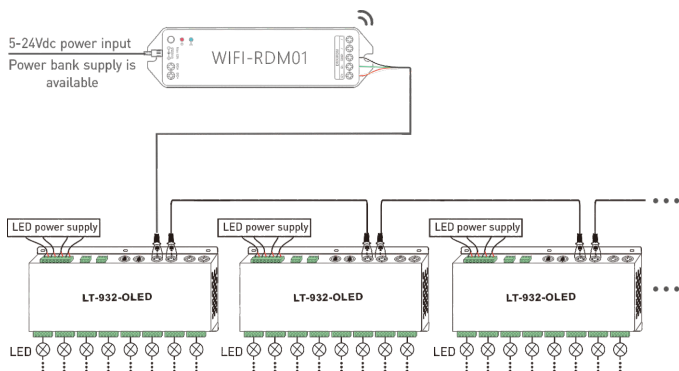

RDM editor App interface instruction

Download the App, setting the LT-932-OLED parameters (frequency, bit, curve, modes, dimming range, screensaver, etc.) after well connecting the RDM editor, more details, please check the manual of WiFi-RDM01.

Well installation of products first, then working with WiFi-RDM01 to realize setting parameters and firmware upgrade by App.

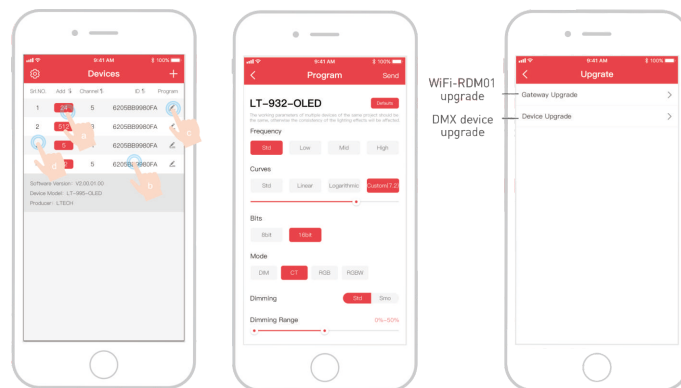

- click "Add", edited the address in corresponding box.
- Click "ID", get more product details.
- Click " ", enter edited interface
- Click "No.", issue the recognizing command.

Supporting WiFi-RDM01 upgrade and DMX driver upgrade.