

E610P 0-10V Dimmer



FC CE RoHS

warranty
5 years



1. Technical Specs:

E610P 0-10V Dimmer

Input Voltage:	100~240Vac, 50-60Hz	Working Temp.:	-10°C~35°C
Switching Power:	90~250Vac, 5A	Dimensions:	L86×W86×H50(mm)
Output:	0~10V Max. 50mA	Package Size:	L106×W106×H60(mm)
Inrush current:	≤100A / 10msec	Weight[G.W.]:	220g

2. Installation Instruction:

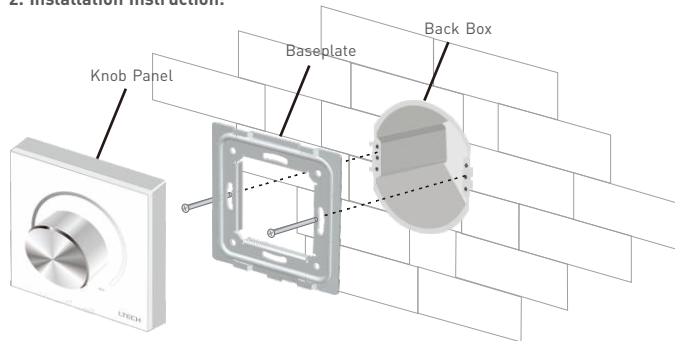

Typical back box as follow:

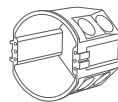

European style

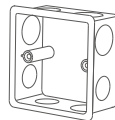

86 size

3. Product Size:

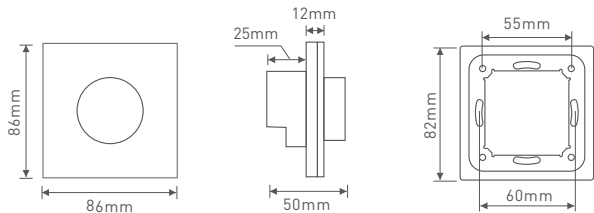

4. Knob Function:



5. Terminals:

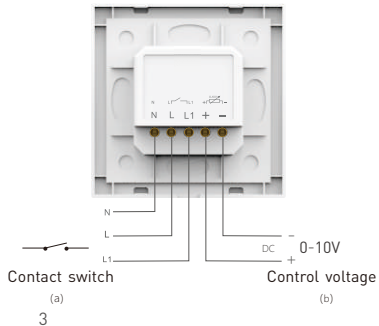

3

6. Wiring Diagram:

6.1 Dimming

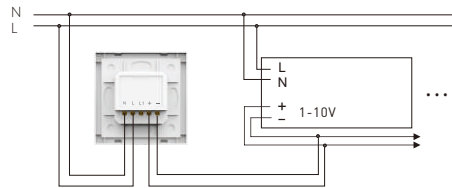

6.2 Built-in power switch

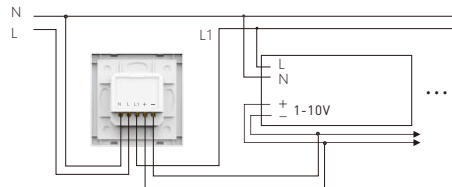

6.3 External relay connection

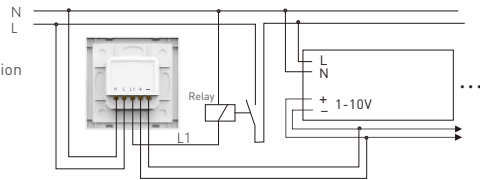

4