

WiFi-104 WiFi Lighting Control System



WiFi-104 is a versatile office/home lighting control system. Through WiFi function build-in mobile devices could control various types of LED lighting products after installing related software on our iOS or Android phones, tablet PCs and other mobile devices. It makes the LED lighting control more intelligence, networking and humanization.

WiFi-104 lighting control system integrated with four functional controls including dimming, color temperature adjusting, RGB and RGBW, which could be set as single color, color temperature(nature white + warm white and nature white + warm white + cool white), RGB and RGBW five types. Easy to control installed various of LED lights on WiFi Software. Meanwhile, it supports max 12 zones control. We could do what you think!

WiFi-104 control system supports connection directly or by router:

In directly connection, mobile phone, pad can directly control the WiFi-104 controller + R4-5A/R4-CC wireless control, without any third party of network equipment ;

Connection by a router, in addition to reach all the functions of direct connection and will not affect the normal Internet function at the same time, the most important part is to support the software interface to switch multi-control systems, control independent of each other systems more convenient, for example, supporting 24 zones in two systems.

In addition, you can DIY the lighting on software according to your habits. You can DIY any color, any changing you like. It will let yourself relish in your sense of accomplishment for your special life color.

You can also use our 2.4G RF remote M12 if there is no software, more options for you.

1. Product Parameter:

WiFi-104 Controller

- Communication Standard: 2.4GHz Wi-Fi, 802.11b/g/n Protocol
- Input Voltage: DC12V~DC24V
- Max Current Load: 4A x4CH Max 16A
- Max Output Power: 192W/384W(12V/24V)
- WiFi Control Distance: 100m(Distance of cross-eyed)

- Working Temperature: -20°C~50°C
- Product Size: L128×W73×H45mm
- Package Size: L135×W80×H50mm
- Weight(G.W.): 290g

R4-5A Constant Voltage Zone Receiver

- Wireless Frequency: 2.4GHz
- Input Voltage: DC5V~DC24V
- Max Current Load: 5A × 4CH Max 20A
- Max Output Power: 100W/240W/480W(5V/12V/24V)
- Remote Distance: 50m(Distance of cross-eyed)
- Working Temperature: -20°C~50°C
- Product Size: L175×W44×H30mm
- Package Size: L178×W48×H33mm
- Weight(G.W.): 110g

R4-CC Constant Current Zone Receiver

- Wireless Frequency: 2.4GHz
- Input Voltage: DC12V~DC48V
- Output Voltage: DC3V~DC46V
- Output Current: CC350/700/1050mA×4CH (3 in 1)
- Output Power: 1.05W~48.3W×4CH Max 193.2W
- Remote Distance: 50m(Distance of cross-eyed)
- Working Temperature: -20°C~50°C
- Product Size: L175×W44×H30mm
- Package Size: L178×W48×H33mm
- Weight(G.W.): 110g

M12 Remote Control

- Working Voltage: DC3V(CR2032 button battery)
- Transmitting Frequency: 2.4GHz
- Remote Distance: 30m(Distance of cross-eyed)
- Dimensions: L104×W60×H9mm
- Weight (G.W): 42g

Software Technology Parameters

- Operation Platform: No Lower Than Android 2.3 or iOS6.0
- Screen Resolution: Above 960*640
- WiFi Function: Must Have WiFi Function
- Byte: Android Edition (932K); iOS Edition (2.8MB)
- Language: English
- Category: Appliance
- Other: Free, No Plug-ins

2. Configuration Diagram

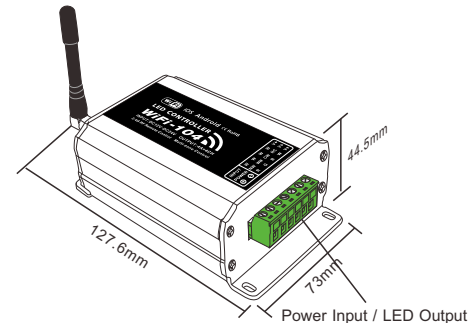

Side A

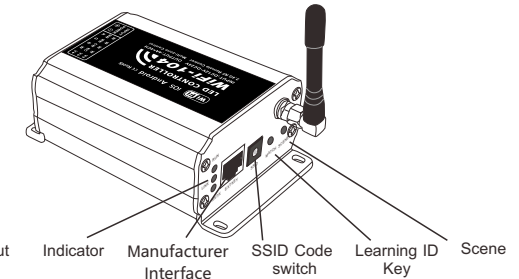

Side B

3. Controller Operating Instructions

(1) Install / Uninstall ANT

Install the WiFi antenna clockwise,
Uninstall anticlockwise

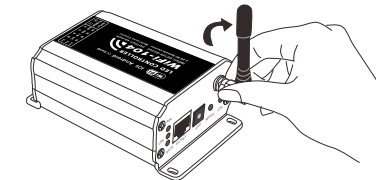

ANT installation instruction

(2) Indicator Light Instructions

Indicator light	Instructions
● RUN	It flashes quickly about 25s during the electric initialization. Flashes once per second after initialization
● LINK	It keeps on when the mobile device connected with WiFi controller, and turns off when disconnected.
● RX/TX	It turns on when the controller receives or transmits the WiFi data. Turns off in the free time.

(3) SSID Number Setting

Set the controller's SSID number with code switch, SSID number range from WiFi-104-SSID-0 to WiFi-104-SSID-F, total 16 No. which means our product could set 16 isolated LAN in the same area. The controller will re-enter initialization status once the code switch changes. RUN indicator light will flash quickly about 25 seconds, mobile device need to search and connect WiFi again after Initialization finished.

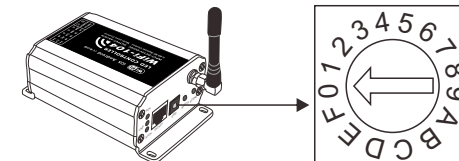

(4) MATCH Key and SCENE Key

Short press **MATCH** key, WiFi controller begins its learning ID status for the standard M12 remote (learning method, see P7)

Short press **SCENE** key sequentially to the user-saved scene modes, 4 scene total.

[Restore factory settings/Delete password]

Long press **MATCH** key and **SCENE** key simultaneously more than 2 seconds, the machine will back to the default parameter, including the parameters of changing modes, zone and group parameters and network parameters. Machine default parameters: Only the 1st zone is present, default RGBW mode, the changing mode is RGB skipping, the brightest is white, no groups, network SSID is WiFi-104-SSID-X (X is the actual coding switch corresponding SSID values), WiFi-104 controller restore as directly connect and the connection password is blank.

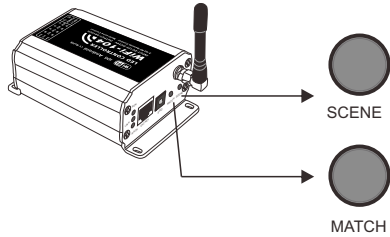

SCENE Key and MATCH Key

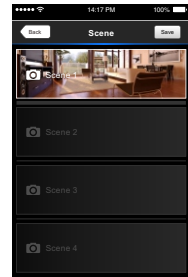

Scene Interface

4. The instructions of APP software:

A. Download App software



iOS scan for download



Android scan for download

B. How to operate the APP software

(1) Network connection setting way

WiFi-104 support 2 connection modes: Directly connection as router or connect by additional router.

- The mode of connecting WiFi controller as a router

Enter mobile device's WiFi setting, click the WiFi function, mobile device search the WiFi and list the working WiFi controller automatically(As Legend-1), Click the SSID number to connect (default is no password).

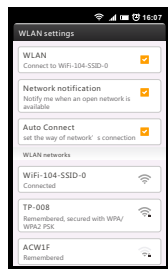

Android WiFi connection

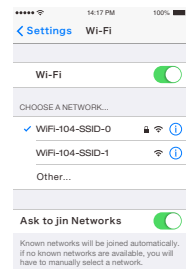

Apple WiFi connection

(Legend-1)

- The mode of connect with a additional router:

Connect WiFi-104 controller to the additional router network:

A. Connect to the WiFi-104 controller, the same step as (1)

B. Click mobile device's icon to start the software, the software will search and list the working WiFi controller automatically, and there is a blue wireless icon (as Legend-2-1)

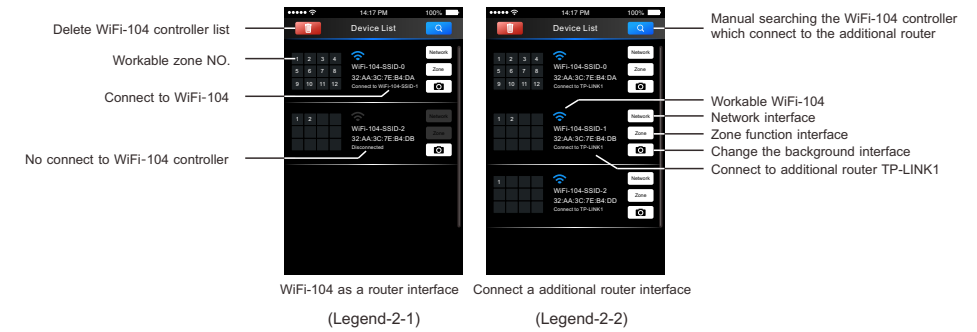

WiFi-104 as a router interface

Connect a additional router interface

(Legend-2-1)

(Legend-2-2)

C. Click "Network" key to enter Network interface(as legend-3-1), start "connect to exiting LAN", software will search the workable WiFi net SSID list, choose the specified router to connect (Note: do not choose WiFi-104 controller), can add the WiFi-104 controller to the wireless router(as legend-3-2 the wireless router TP-LINK1)

Repeat the ABC steps if you need connecting multiple WiFi-104 controller to this wireless router.

D. Exit WiFi-104 software, enter mobile device setting-wireless network setting, choose the wireless router to connect. start WiFi-104 software once more, device list interface as legend-2-2. Completes the steps to connect to the additional router.

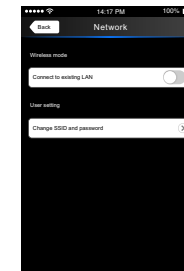

(Legend-3-1)

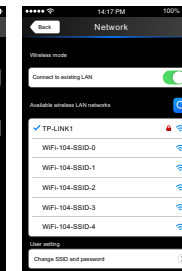

(Legend-3-2)

Network interface

Note: In this connection mode, to avoid the mobile device automatically connect to WiFi-104 after the setting has completed, please click "workable WiFi-104" which under the mobile device "WiFi setting" and at the message box please click "Forget this network"(apple iOS) or "Cancel save" (SUNMUNG mobile phone is "forget") to cancel the save of WiFi-104 connection.



Android cancel store the WiFi-104 connection

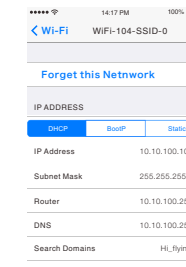

Apple cancel store the WiFi-104 connection

(2) Main interface (5 types total)

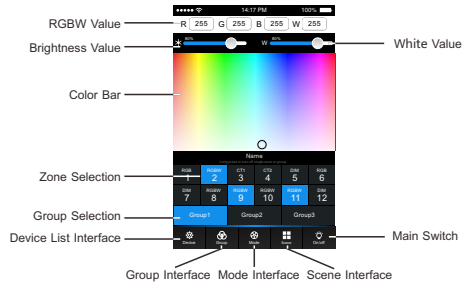

5 Main interface



(3) The learning method of Zone control

(1) Turn on zone control

Click "Zone" on the **Device list** interface, enter **Zone set** interface. according to the lighting control requirements, turn on multiple zone, select the light type and naming zone.

[Note]: Default WiFi-104 controller itself as NO.1 zone, which can select if to connect lights. If not, sub-control can be replaced as the first zone.

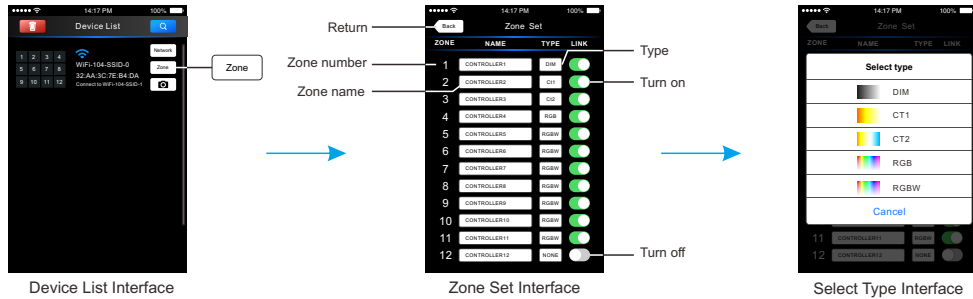

(2) Learning ID:

Short press "ID learning button" on the receiver, the running light go flash to keeps on. Then select the zone number on the software interface and touch the color bar 2-3 seconds. Long buzzer (meantime the running light returns to flash), zone control and master control matched successful.

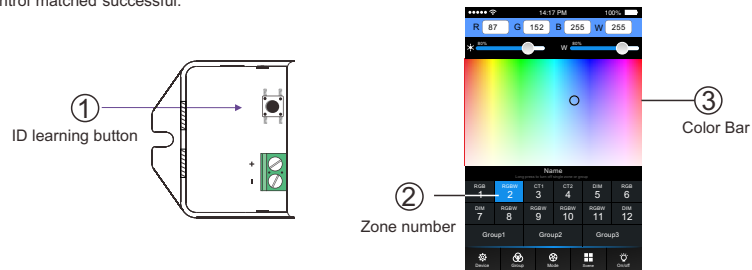

(3) Cancelling ID:

Long press "ID learning button" for 5 seconds, buzzer sound long and loud, success to cancel the zone control learning

(4) Group

Group Feature :

- Group can control several zones at the same time, and several zones can adjust color, color temperature and brightness together.
- You can set up Max 3 groups, all zones at the same groups must be the same type, and one zone can belong to multiple groups simultaneously.
- Set up the group to enabled status, then the corresponding group will appear in the main interface
- It will automatically cancel the relevant zone group settings as you changed the type or set up enabled status of the zone at the Zone Set interface.

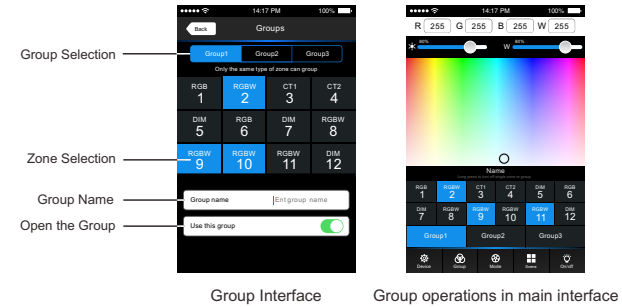

(5) Mode Interface for RGB / RGBW Type

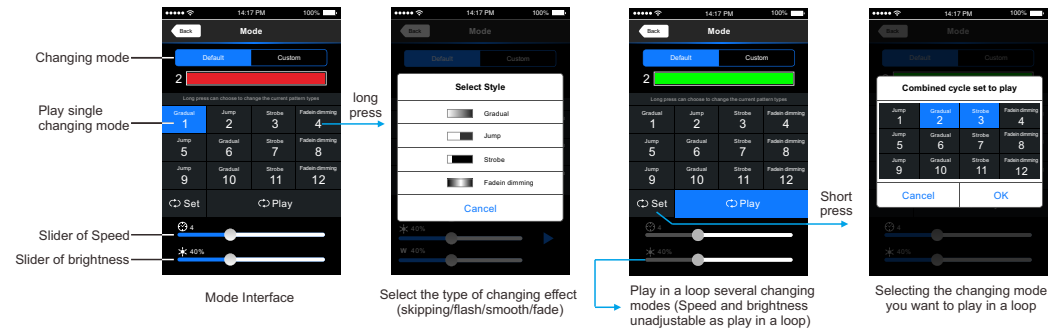

(6) DIY Interface

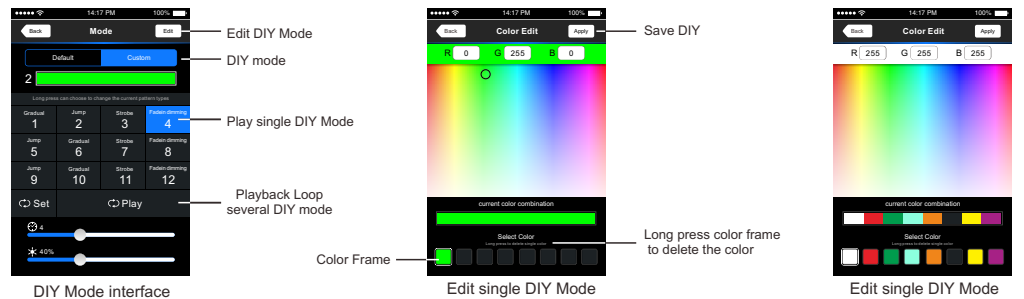

7). Scene Interface

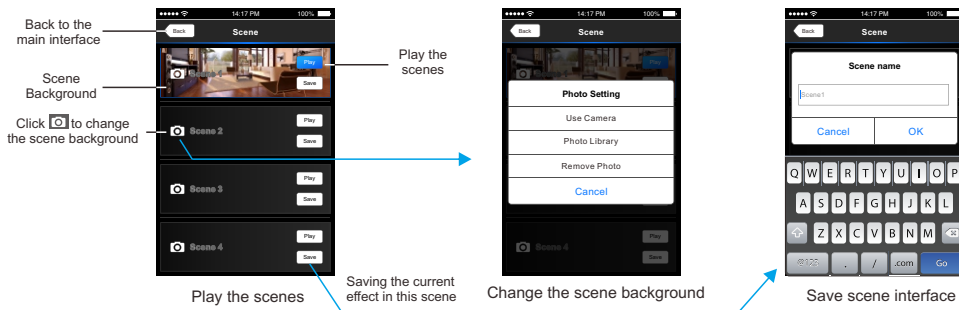

5. WiFi Network SSID Name and Password Setting

In Device list interface, click "Network key" to enter Network interface, select "Change SSID and Password" (Click ">") to enter User Setting interface. Typing new SSID name and password (Min.: 8 characters, consist of 0-9, a-z and A-Z). Click "Apply" button on the top right corner of the interface to save the changes.

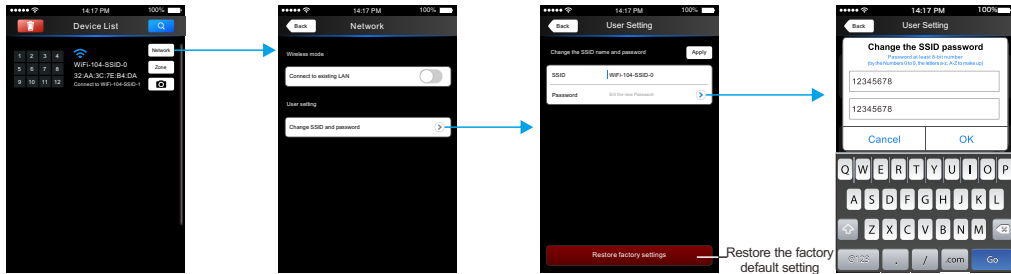

1. Device List interface 2. Network interface 3. Change SSID name interface 4. Change SSID password interface

[Note]: In direct connection of the WiFi-104 as a router. Please exit software after changed the SSID name and the password, then enter the mobile device system setting to reconnect the WiFi-104

In additional wireless router connection, it only needs to click "🔍" in Device List interface to search again the WiFi-104 controller after changed SSID name.

[Note]: If you forget the WiFi network password, please simultaneously press : "MATCH" and "SCENE" more than 2s to restore the factory default settings, so that can delete the WiFi network password (More details in page 3 [Restore factory settings/Delete password])

6. Remote operating Instructions

Learning ID

Short press learning key "MATCH" in WiFi-104 controller, long buzzer, then press any keys on M12 remote, long buzzer again, succeed learning.

Cancel ID

Long press learning key "MATCH" in WiFi-104 controller more than 6s, long buzzer, succeed cancel (cancel all learned remotes with WiFi-104).

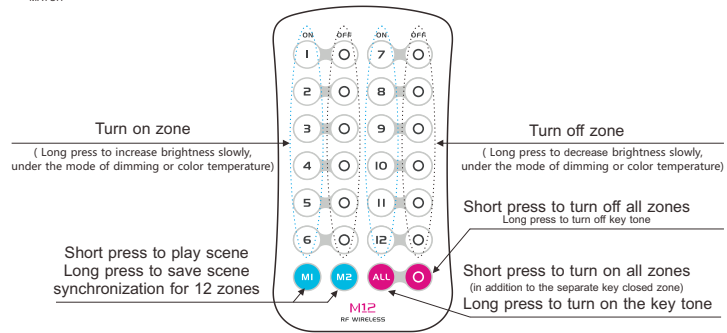

7. Wiring Diagram

1) Connect to the zones controller and LED lamps (the same way of WiFi-104 connection)

[Note]: WiFi-104 default to first zone, Master controller can choose whether connecting to LED lamps or not. If not, use wireless control to instead of the first zone.

Multiple partitions can be set to the same type or several types, such as all partitions are single color, can be set to DIM dimmer light type, such as dimmer, color temperature, RGB, and other types of lamps, different partition set to different types of lamps, the lamps connection diagram as follows:

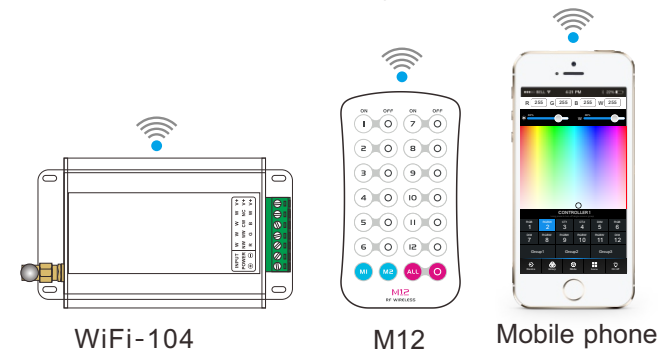
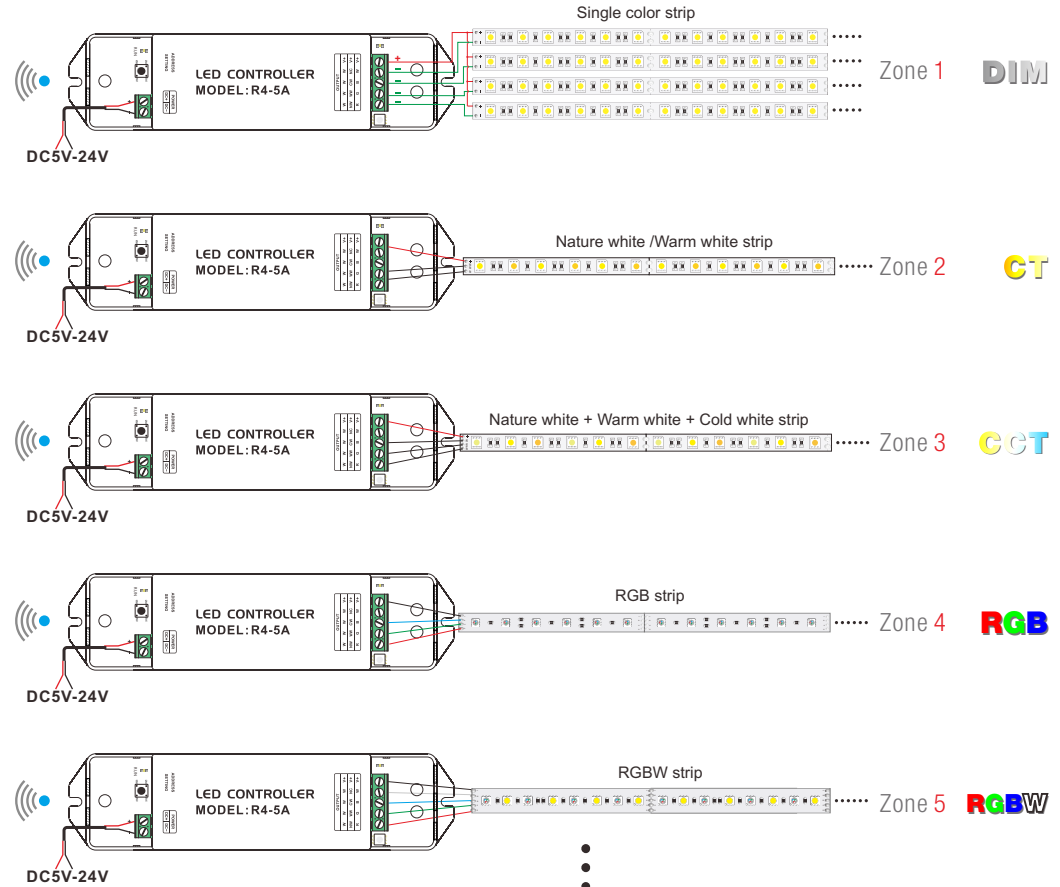

2) Direct connection of WiFi-104 as router.

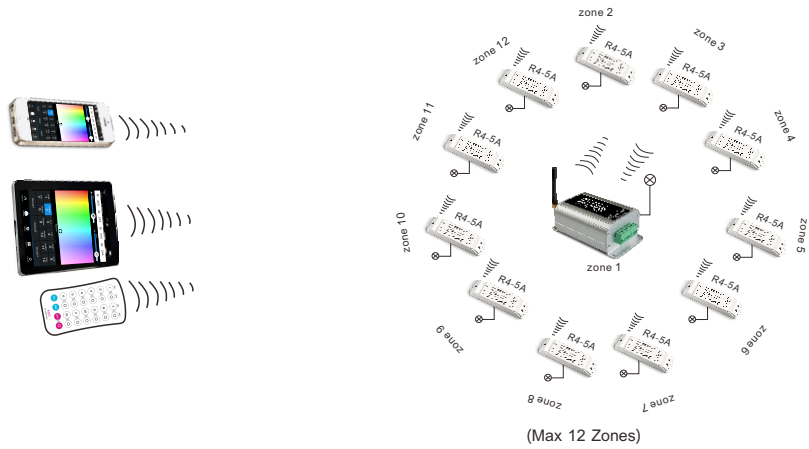

3) Connect by a router

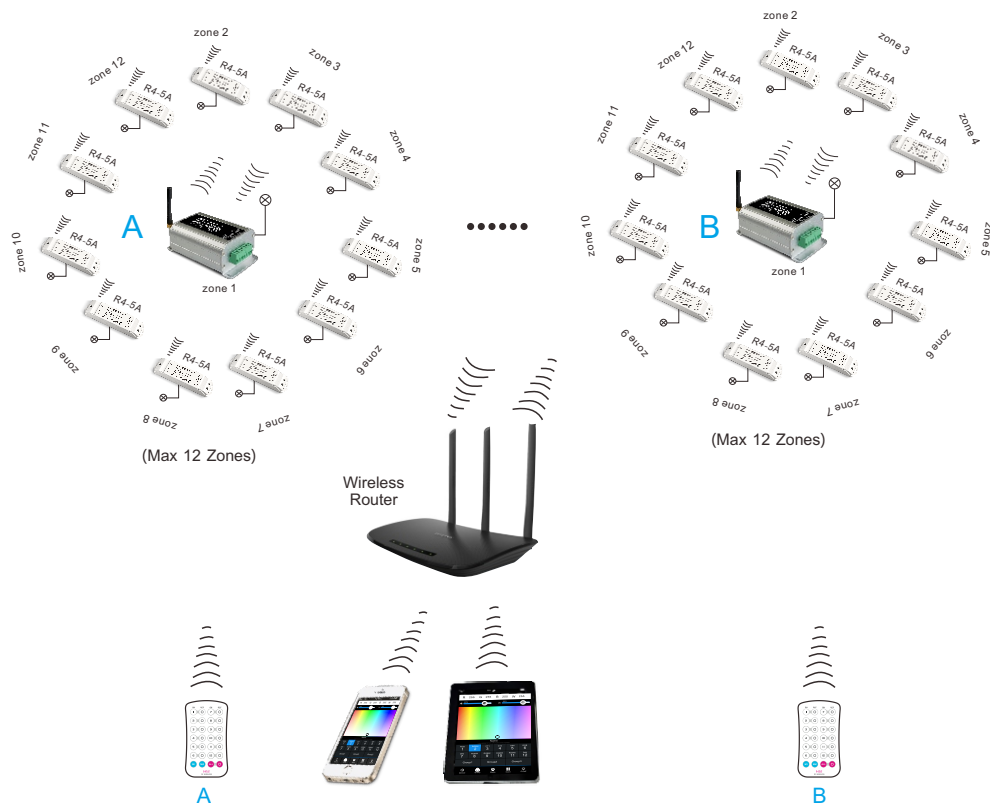

[Note] Unlimited zone receiver R4-5A/R4-CC can be installed for each zone within effective range.

4) Remote distance reference

[Note]: The following distance is measured at distance open environment, in an open environment testing wireless distance will be reduced, please refer to our actual test distance before installation.

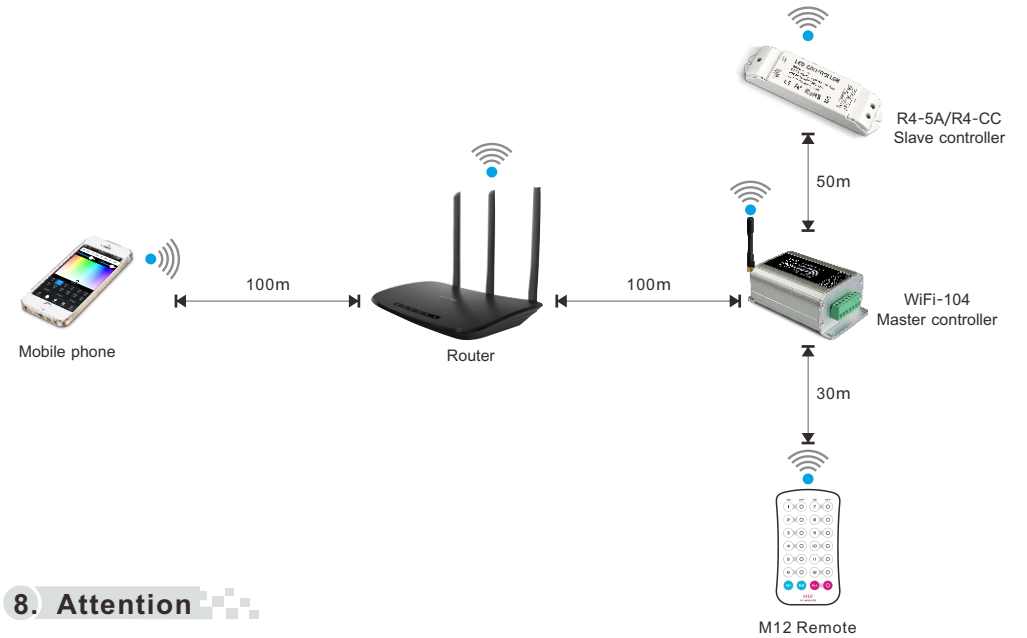

8. Attention

1. The product shall be installed and serviced by a qualified person.
2. This product is non-waterproof. Please avoid the sun and rain. When installed outdoors please ensure it is mounted in a water proof enclosure.
3. Good heat dissipation will prolong the working life of the controller. Please ensure good ventilation.
4. Please check if the output voltage of any LED power supplies used comply with the working voltage of the product.
5. Please ensure that adequate sized cable is used from the controller to the LED lights to carry the current. Please also ensure that the cable is secured tightly in the connector to avoid the accidents due to overheat and poor contact on the wire.
6. Ensure all wire connections and polarities are correct before applying power to avoid any damages to the LED lights.
7. If a fault occurs please return the product to your supplier. Do not attempt to fix this product by yourself.

9. Warranty Agreement

1. We provide lifelong technical assistance with this product:
 - A 5-year warranty is given from the date of purchase. The warranty is for free repair or replacement and covers manufacturing faults only.
 - For faults beyond the 5-year warranty we reserve the right to charge for time and parts.
2. Warranty exclusions below:
 - Any man-made damages caused from improper operation, or connecting to excess voltage and overloading.
 - The product appears to have excessive physical damage.
 - Damage due to natural disasters and force majeure.
 - Warranty label, fragile label and unique barcode label have been damaged.
 - The product has been replaced by a brand new product.
3. Repair or replacement as provided under this warranty is the exclusive remedy to the customer. Ltech shall not be liable for any incidental or consequential damages for breach of any stipulation in this warranty.
4. Any amendment or adjustment to this warranty must be approved in writing by Ltech only.

★ This manual only applies to this model. Ltech reserves the right to make changes without prior notice.